



CARRON
PHOENIX

The Carron Phoenix Sink & Tap Main Range

SEPTEMBER 2024



DELIVERING INSPIRATION FOR YOUR KITCHEN

The **Carron Phoenix** story began in 1759 when the Carron Iron Company was founded near the town of Falkirk in Central Scotland.

CONTENTS

The story of Carron Phoenix	02
Choosing a sink and tap	03
Materials and finishes	04

GRANITE SINKS	05
Bali	07
Haven	08
Debut	11

SYNTHETIC SINKS	13
Janus	14

STAINLESS STEEL SINKS	15
Ibis	16
Adelphi	17
Maui	18
Zeta	19
Atoll	22
Rapid	23
Lomond ^{NEW}	25
Deca Inset / Undermount	27
Zeta Undermount	31
Ibis Undermount	32
Carisma Inset / Undermount	33

CERAMIC SINKS	34
Sienna	35
Shonelle	36
Belfast	37
Carlow	39
Waterford Inset / Undermount	40

TAPS	41
Filter Taps	42
Mixer Taps	43

WASTE MANAGEMENT	47
Carronade Elite WDU's	48
Linea Waste Sorter Bins	49

1759 Carron Iron Company founded near Falkirk in

1776 Carron Iron Company produces first cannons

1774 Moving into Sink manufacture *Esto Perpetua* ('Ever lasting') motto is introduced

1814 Carron becomes Europe's biggest Iron Works

1920 Carron Iron Company starts producing telephone and pillar boxes

1960 Carron begins Stainless Steel Sink production

1991 Carron Range extends to Taps and Accessories. **2007** includes Waste Management Systems **2013** Introduces Instant Boiling Water Tap

Famed for the manufacture of the iconic red telephone boxes and pillar boxes still in use throughout the UK today, the Carron Iron Company was considered to be the centre of the industrial revolution in Scotland and quickly became the largest iron works in Europe.

Moving forward more than 250 years Carron Phoenix is now one of the leading manufacturers of kitchen sinks in the UK. Our sink design philosophy means that we do not compromise between stylish good looks and practicality. Whether Granite, Stainless Steel or Ceramic, all of our sinks are guaranteed for a lifetime, so you can be confident that they are of exceptional quality and are made to last.

To complement the perfect sink, our extensive range of taps, accessories and waste management systems, gives you an all-round solution for getting the most from your kitchen sink space. Carron Phoenix manufactures products that are beautiful to look at and excellent to work with.

Guarantees valid only on products placed and used in standard domestic situations

GUARANTEES

As Carron Phoenix sinks are built to the highest manufacturing standards, we are proud to offer an extensive guarantee on all of our products against manufacturing defects.

Full details of our guarantees can be found on: www.carron.com/guarantee

2 YEAR GUARANTEE Two year guarantee for accessories

5 YEAR GUARANTEE Five year guarantee for standard taps

LIFETIME GUARANTEE Lifetime guarantee for sinks

Choosing a sink

There are a number of factors to consider when choosing your kitchen sink; functionality is just as important as design, and here is a short guide to the initial decisions you will need to make before choosing the right model for you and your kitchen.

Sink configurations and cabinet size

Whether you prefer the larger capacity of a single bowl or the versatility offered by a one and a half bowl sink, there are options to suit. The following symbols are used throughout this brochure as a guide.



Left hand drainer:
The drainer is to the left of the main bowl.



Right hand drainer:
The drainer is to the right of the main bowl.



Reversible drainer:
The sink has tap holes front and back to allow the sink to be fitted with the drainer to the left or the right.



Left hand 1/2 bowl:
For sinks without a drainer but multiple bowls. Indicates the small bowl is to the left of the main bowl.



Right hand 1/2 bowl:
For sinks without a drainer but multiple bowls. Indicates the small bowl is to the right of the main bowl.



Inset

Inset sinks are mounted from above, and the edge of the sink sits on top of the worktop. This is the most standard type of installation and can be used with all worktop types, including laminate worktops. Inset sinks generally have a drainer board and are available in a wide range of styles and materials to suit your preference.



Undermount

When your worktop is made from a solid-surface material, such as granite, solid wood or engineered stone, you have the option of choosing an undermounted sink. This style is installed from beneath the work surface and allows for a clean minimalist look to the kitchen. Drainer grooves are often cut into the work surface to complete the elegant look.

It is essential to check the cabinet size of your kitchen to ensure that the sink will fit. Throughout the brochure, 'Min Cabinet' indicates the minimum cabinet size (measured left-to-right) required to allow the sink to fit.

Choosing a tap

Throughout our brochure we offer a wide choice of sinks to suit all tastes. Each of these sinks is shown with a Henley tap. However, if you would like to upgrade your tap to your choice and specification, please refer to pages 41-46 for our full range.



Perlator: Mixes air into the flow of water to give a champagne-like flow.

Materials and finishes

Kitchen sinks are available in a range of materials to suit your particular requirements and design preferences. Whichever material you choose, you can rest assured that your Carron Phoenix sink is manufactured to the highest standards.



Stainless Steel is available in **P** **B** **U**

An established favourite, stainless steel sinks are practical, hard-wearing and easy to clean. Available in polished, unbrushed or brushed finishes.



Granite is available in **PW** **CO** **SG** **ON** **MB**

Manufactured using real granite particles, this material gives you the design flexibility to introduce colour into your sink area and offers exceptional performance for the life of your kitchen.



Synthetic is available in **AW** **GP**

Using a newly-developed proprietary coating, our synthetic sinks offer excellent heat, shock and impact resistance at a value-for-money price level.



Ceramic is available in **WH**

Whether your kitchen design is traditional or contemporary, the lustre of a fine-fireclay ceramic sink will add a touch of elegance.

GRANITE

A beautifully tactile material which allows you to make a real statement in your kitchen. The versatility of granite allows Carron Phoenix to create a range of designs which combine form and function perfectly.

Bali 100 in Polar White with Dante Pull-Out tap in black

Each Carron Phoenix sink is supported by a **Lifetime Guarantee** against manufacturing defects



Choice of colours

Our granite sinks come in a choice of classic and contemporary neutrals, that offer superb design scope for combining with a wide range of work surface materials. Some of our colours contain metallic particles for a beautifully subtle, but rich appearance.

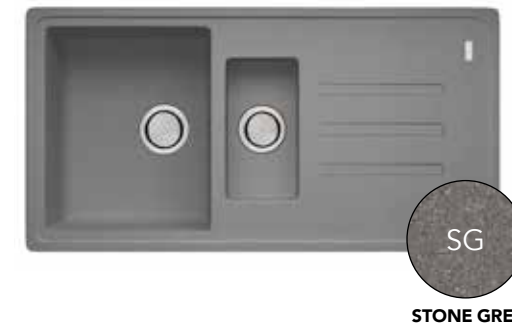

No other kitchen sink material offers the durability and hard-wearing properties of Carron Phoenix Granite. We use real Granite particles – the fourth hardest material known to man as the main component of every sink.

Scratch resistant, stain resistant, temperatureresistant to 280oC and easy to clean, Carron Phoenix Granite sinks will retain their great looks for a lifetime.

When you're looking for a beautiful and hard working sink, granite is the ultimate choice. Furthermore, each Carron Phoenix sink is supported by a Lifetime Guarantee against manufacturing defects.



YOU CAN'T SCRATCH IT
Knives and forks won't mark or score the surface.



YOU CAN'T SCORCH IT
Even at 280°C the surface will not burn.



YOU CAN'T STAIN IT
Carron Granite sinks are highly resistant to staining, marking and fading.



EASY TO CLEAN
Carron Granite sinks are now 30% smoother than before and even easier to keep clean.



SANITIZED®



Sanitized®

Kitchens can be a critical location for the spreading of bacteria and on unprotected materials, bacteria can multiply every twenty minutes and have a negative effect on hygiene.

The integrated Sanitized® hygiene function in each Carron Phoenix Granite sink helps to keep your sink area clean and provides your sink with lasting protection.

Sanitized® helps to keep the surface protected from bacteria and microbe growth after and in-between cleaning, and helps to reduce the risk of transferring bacteria and microbes from the sink surface to food or other objects. The biocidal substance locates bacteria via moisture on the surface and then deactivates it, reducing its growth and multiplication by 99%.

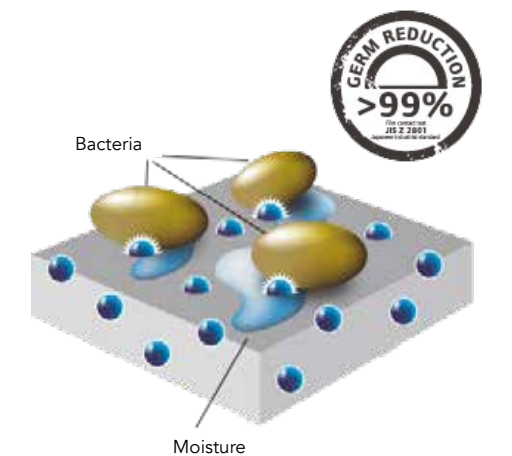

BALI

Bali brings a superb combination of style and grace to any kitchen space following the 'less is more' rule of styling. Available in two models and complemented by a range of modern yet practical accessories. Bali offers both simplicity and functionality for any busy kitchen.

Sinks shown with Henley tap
Henley tap Chrome - 115.0254.448

Bali 105

Shown in Onyx

Pack RRP **£743**
Sink only RRP **£536**



- PW 114.0055.859
- SG 114.0055.863
- ON 114.0159.244

DIMENSIONS	Left to Right:	970mm
	Front to Back:	500mm
BOWL DIMENSIONS	Left to Right:	460mm
	Front to Back:	390mm
BOWL DEPTH		190mm
CUT OUT DIMENSIONS	Left to Right:	950mm
	Front to Back:	480mm
CORNER RADIUS		20mm
MINIMUM CABINET		600mm

OTHER – Suitable for WDU – Yes
Revolution Waste included

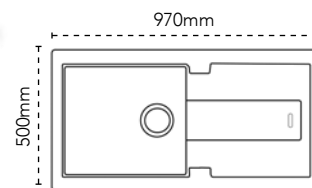

Bali 150

Shown in Polar White

Pack RRP **£790**
Sink only RRP **£583**



- PW 114.0055.862
- SG 114.0055.865
- ON 114.0159.252

ACCESSORIES **£91** - 112.0067.976



DIMENSIONS	Left to Right:	970mm
	Front to Back:	500mm
1ST BOWL DIMENSIONS	Left to Right:	350mm
	Front to Back:	390mm
2ND BOWL DIMENSIONS	Left to Right:	160mm
	Front to Back:	320mm
BOWL DEPTH		190mm / 120mm
CUT OUT DIMENSIONS	Left to Right:	950mm
	Front to Back:	480mm
CORNER RADIUS		20mm
MINIMUM CABINET		600mm

OTHER – Suitable for WDU – In main bowl only
Revolution Waste included

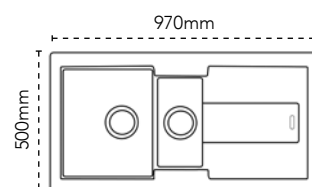

HAVEN

Haven opens up the design potential for undermounting Granite sinks into a wide range of work surface materials. With its choice of beautifully neutral tones and contemporary shades, Haven offers an appealing and high performance alternative to Stainless Steel.

Sinks shown with Henley tap
Henley tap Chrome - 115.0254.448

Haven 90

Shown in Coffee

Pack RRP **£619**
Sink only RRP **£412**



- PW 125.0696.027
- SG 125.0696.028
- MB 125.0696.026
- CO 125.0696.029

DIMENSIONS	Left to Right:	403mm
	Front to Back:	433mm
BOWL DIMENSIONS	Left to Right:	370mm
	Front to Back:	400mm
BOWL DEPTH		200mm
CUT OUT DIMENSIONS	Left to Right:	370mm
	Front to Back:	400mm
CORNER RADIUS		30mm
MINIMUM CABINET		450mm

OTHER – Suitable for WDU – Yes
Revolution Waste included

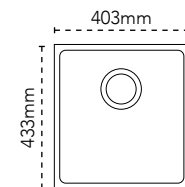

Haven 150 -16
in Polar White
with Sift Filter tap
in Chrome



Haven 100
in Matt Black
with Reno Tap
in Onyx

Sinks shown with Henley tap
Henley tap Chrome - 115.0254.448

Haven 100

Shown in Stone Grey

Pack RRP **£671**
Sink only RRP **£464**



- PW 125.0696.031
- SG 125.0696.032
- MB 125.0696.030
- CO 125.0696.033

ACCESSORY **£40** - 112.0018.988



DIMENSIONS	Left to Right: 533mm Front to Back: 433mm
BOWL DIMENSIONS	Left to Right: 520mm Front to Back: 400mm
BOWL DEPTH	200mm
CUT OUT DIMENSIONS CORNER RADIUS	Left to Right: 520mm Front to Back: 400mm 30mm
MINIMUM CABINET	600mm

OTHER – Suitable for WDU – Yes
Revolution Waste included

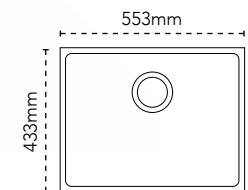

ACCESSORY **£40** - 112.0018.988



DIMENSIONS	Left to Right: 553mm Front to Back: 433mm
1ST BOWL DIMENSIONS	Left to Right: 340mm Front to Back: 400mm
2ND BOWL DIMENSIONS	Left to Right: 150mm Front to Back: 400mm
BOWL DEPTH	200mm/150mm
CUT OUT DIMENSIONS CORNER RADIUS	Left to Right: 520mm Front to Back: 400mm 30mm
MINIMUM CABINET	600mm

OTHER – Suitable for WDU – Yes
Revolution Waste included

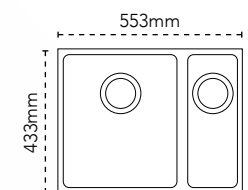

Haven 150-16

Shown in Coffee

Pack RRP **£722**
Sink only RRP **£515**



LHSB

- PW 125.0717.262
- SG 125.0717.263
- MB 125.0717.261
- CO 125.0717.120

RHSB

- PW 125.0696.035
- SG 125.0696.036
- MB 125.0696.034
- CO 125.0696.037



DEBUT



Our Debut range offers a modern touch to a classic design, with soft drainer grooves and gentle corners, this sink offers a great deal of functionality. Available in three models and each complemented by a range of accessories, Debut is a hard-working addition to your kitchen.

Upgrade to your ideal tap!

See our taps range on pages 41 - 46

Upgrade to your ideal tap!

See our taps range on pages 41 - 46

Sinks shown with Henley tap
Henley tap Chrome - 115.0254.448

Sinks shown with Henley tap
Henley tap Chrome - 115.0254.448

Debut 100

Shown in Stone Grey

Pack RRP **£659**
Sink only RRP **£452**



- PW 114.0201.152
- SG 114.0252.361
- ON 114.0252.349
- CO 114.0201.150

ACCESSORY **£40** - 112.0018.988



DIMENSIONS	Left to Right: 780mm Front to Back: 500mm
BOWL DIMENSIONS	Left to Right: 340mm Front to Back: 420mm
BOWL DEPTH	200mm
CUT OUT DIMENSIONS CORNER RADIUS	Left to Right: 760mm Front to Back: 480mm 20mm
MINIMUM CABINET	450mm

OTHER – Suitable for WDU – Yes
Revolution Waste included

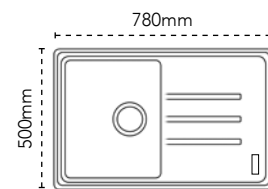

ACCESSORY **£76** - 112.0255.465



DIMENSIONS	Left to Right: 970mm Front to Back: 500mm
1ST BOWL DIMENSIONS	Left to Right: 450mm Front to Back: 420mm
BOWL DEPTH	200mm
CUT OUT DIMENSIONS CORNER RADIUS	Left to Right: 950mm Front to Back: 480mm 20mm
MINIMUM CABINET	600mm

OTHER – Suitable for WDU – Yes
Revolution Waste included

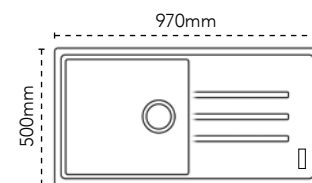

Debut 105

Shown in Polar White

Pack RRP **£677**
Sink only RRP **£470**



- PW 114.0288.187
- SG 114.0288.192
- ON 114.0288.193

Debut 150

Shown in Onyx

Pack RRP **£691**
Sink only RRP **£484**



- PW 114.0201.155
- SG 114.0252.436
- ON 114.0252.432
- CO 114.0201.153

ACCESSORIES **£93** - 112.0255.467



DIMENSIONS	Left to Right: 970mm Front to Back: 500mm
1ST BOWL DIMENSIONS	Left to Right: 340mm Front to Back: 420mm
2ND BOWL DIMENSIONS	Left to Right: 150mm Front to Back: 290mm
BOWL DEPTH	200mm /100mm
CUT OUT DIMENSIONS CORNER RADIUS	Left to Right: 950mm Front to Back: 480mm 20mm
MINIMUM CABINET	600mm

OTHER – Suitable for WDU – Yes
Revolution Waste included

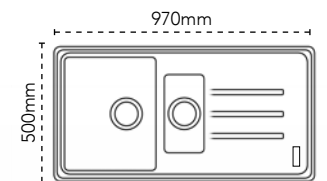



Janus 100
in Arctic White
with Windsor tap
in Chrome

JANUS

The Janus range of synthetic sinks offer great value and have a durable coating ensuring it is a hardworking sink; available in either Arctic White or Graphite colour options.

**Upgrade
to your
ideal tap!**

See our taps range
on pages 41 - 46

Sinks shown with Henley tap
Henley tap Chrome - 115.0254.448

Janus 100

Shown in Arctic White

Pack RRP **£430**
Sink only RRP **£223**



AW 114.0308.256

GP 114.0308.260

DIMENSIONS	Left to Right: 970mm Front to Back: 500mm
BOWL DIMENSIONS	Left to Right: 450mm Front to Back: 420mm
BOWL DEPTH	200mm
CUT OUT DIMENSIONS	Left to Right: 950mm Front to Back: 480mm
MINIMUM CABINET	600mm

OTHER – Suitable for WDU – Yes
Standard Waste included

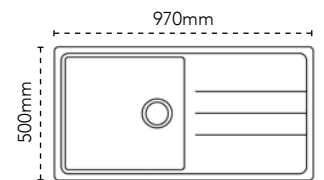

Janus 150

Shown in Graphite

Pack RRP **£459**
Sink only RRP **£252**



AW 114.0308.263

GP 114.0308.264

DIMENSIONS	Left to Right: 970mm Front to Back: 500mm
1ST BOWL DIMENSIONS	Left to Right: 340mm Front to Back: 420mm
2ND BOWL DIMENSIONS	Left to Right: 150mm Front to Back: 290mm
BOWL DEPTH	200mm/100mm
CUT OUT DIMENSIONS	Left to Right: 950mm Front to Back: 480mm
MINIMUM CABINET	600mm

OTHER – Suitable for WDU – In main bowl only
Standard Waste included

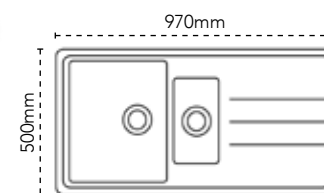

SYNTHETIC

Using a newly developed proprietary coating, our Synthetic sinks offer excellent heat, shock and impact resistance as well as exceptional value for money.

The Carron Phoenix Synthetic sinks are available in a choice of two colours to suit your kitchen design.



Each Carron Phoenix sink is supported by a **Lifetime Guarantee** against manufacturing defects.

STAINLESS STEEL



Each Carron Phoenix sink is supported by a **Lifetime Guarantee** against manufacturing defects.



POLISHED

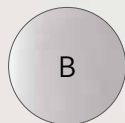

BRUSHED

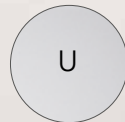

UNBRUSHED

Stainless Steel is the professional's favourite. You can wash and buff it and over time it will develop a beautiful patina. Even with years of rigorous use, Stainless Steel maintains the good looks that have made this material such a popular choice.

All of our sinks are made from high quality Stainless Steel, ensuring their lasting quality and performance.

Practical, stylish and always of the highest quality, it's easy to find the right design for your kitchen within our extensive range of Stainless Steel sinks.



Ibis 150 with Dante tap in Chrome

IBIS

The appeal of Ibis lies in its absolute simplicity. The inset models have low-profile edges, giving an almost seamless finish with the work surface. Clean lines and contemporary styling are echoed throughout the Ibis range, from the drainer pattern to the ergonomic bowl options that are deeper than the average sink.

Sinks shown with Henley tap
Henley tap Chrome - 115.0254.448

Upgrade to your ideal tap!

See our taps range on pages 41 - 46

Ibis 100

Shown in Polished Stainless Steel

Pack RRP **£643**

Sink only RRP **£436**

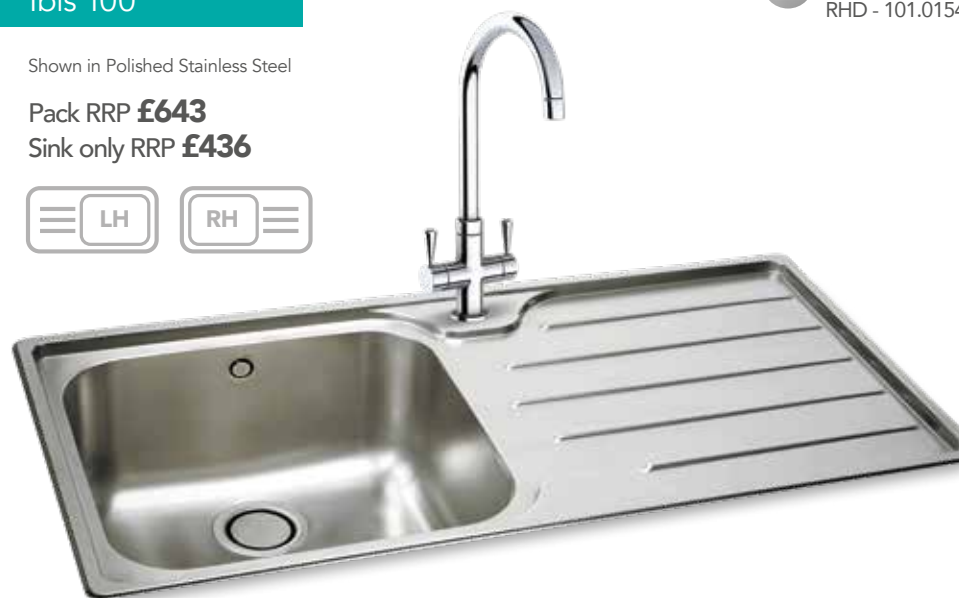

P LHD - 101.0155.229
RHD - 101.0154.519

DIMENSIONS	Left to Right: 1030mm Front to Back: 510mm
BOWL DIMENSIONS	Left to Right: 450mm Front to Back: 420mm
BOWL DEPTH	200mm
CUT OUT DIMENSIONS	Left to Right: 1014mm Front to Back: 494mm
MINIMUM CABINET	600mm

OTHER - Suitable for WDU - Yes
Revolution Waste included

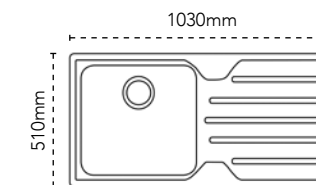

Ibis 150

Shown in Polished Stainless Steel

Pack RRP **£737**

Sink only RRP **£530**



P LHD - 101.0042.891
RHD - 101.0042.910

DIMENSIONS	Left to Right: 1030mm Front to Back: 510mm
1ST BOWL DIMENSIONS	Left to Right: 360mm Front to Back: 420mm
2ND BOWL DIMENSIONS	Left to Right: 170mm Front to Back: 320mm
BOWL DEPTH	200mm/130mm
CUT OUT DIMENSIONS	Left to Right: 1014mm Front to Back: 494mm
MINIMUM CABINET	600mm

OTHER - Suitable for WDU - In main bowl only
Revolution Waste included

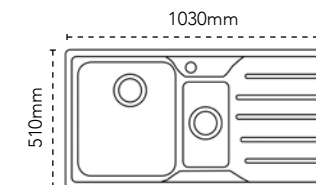

ADELPHI

Boasting an ultra-slim, flush-fit edge profile, Adelphi is a sink that melts almost seamlessly into your work surface, offering an impeccably minimalist appearance. Whether you choose the single or 1.5 bowl option, Adelphi's contemporary and sleek design will remain stylish for years to come.

Sinks shown with Henley tap
Henley tap Chrome - 115.0254.448

**Upgrade
to your
ideal tap!**

See our taps range
on pages 41 - 46

Adelphi 100

Shown in Polished Stainless Steel

Pack RRP **£589**
Sink only RRP **£382**



P 127.0285.738

DIMENSIONS	Left to Right: 940mm Front to Back: 510mm
BOWL DIMENSIONS	Left to Right: 360mm Front to Back: 420mm
BOWL DEPTH	200mm
CUT OUT DIMENSIONS	Left to Right: 924mm Front to Back: 494mm
MINIMUM CABINET	500mm

OTHER – Suitable for WDU – Yes
Revolution Waste included

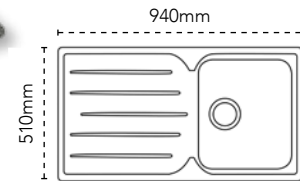

Adelphi 150

Shown in Polished Stainless Steel

Pack RRP **£668**
Sink only RRP **£461**



P 127.0285.739

DIMENSIONS	Left to Right: 1030mm Front to Back: 510mm
1ST BOWL DIMENSIONS	Left to Right: 360mm Front to Back: 420mm
2ND BOWL DIMENSIONS	Left to Right: 170mm Front to Back: 320mm
BOWL DEPTH	200mm / 130mm
CUT OUT DIMENSIONS	Left to Right: 1014mm Front to Back: 494mm
MINIMUM CABINET	600mm

OTHER – Suitable for WDU – In main bowl only
Revolution Waste included

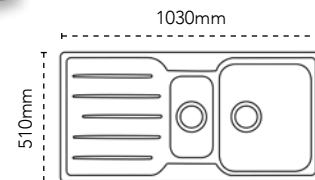

MAUI

The Maui range succeeds in combining soft organic design with precise and contemporary angles. Maui is perfect if you want to make a unique design statement, whilst maintaining the best of Carron Phoenix practicality.

Sinks shown with Henley tap
Henley tap Chrome - 115.0254.448

**Upgrade
to your
ideal tap!**

See our taps range
on pages 41 - 46

Maui 90

Shown in Polished Stainless Steel

Pack RRP **£523**
Sink only RRP **£316**



P LHD - 101.0155.116
RHD - 101.0155.119

DIMENSIONS	Left to Right: 900mm Front to Back: 500mm
BOWL DIMENSIONS	Left to Right: 370mm Front to Back: 400mm
BOWL DEPTH	200mm
CUT OUT DIMENSIONS	Left to Right: 884mm Front to Back: 484mm
MINIMUM CABINET	500mm

OTHER – Suitable for WDU – Yes
Revolution Waste included

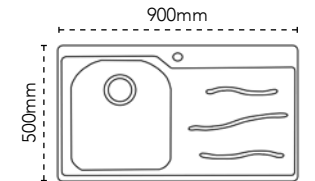

Maui 150

Shown in Polished Stainless Steel

Pack RRP **£638**
Sink only RRP **£431**



P LHD - 101.0155.121
RHD - 101.0155.124

DIMENSIONS	Left to Right: 1030mm Front to Back: 500mm
1ST BOWL DIMENSIONS	Left to Right: 370mm Front to Back: 400mm
2ND BOWL DIMENSIONS	Left to Right: 160mm Front to Back: 360mm
BOWL DEPTH	200mm/130mm
CUT OUT DIMENSIONS	Left to Right: 1014mm Front to Back: 484mm
MINIMUM CABINET	600mm

OTHER – Suitable for WDU – In main bowl only
Revolution Waste included

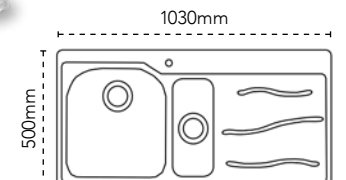

ZETA

Zeta's modern design combines straight lines with soft curves and the low profile perimeter gives added design appeal. Available in three inset models, Zeta is user-friendly with spacious bowls and practical accessories.

Sinks shown with Henley tap
Henley tap Chrome - 115.0254.448

**Upgrade
to your
ideal tap!**

See our taps range
on pages 41 - 46

Zeta 90

Shown in Polished Stainless Steel

Pack RRP **£501**
Sink only RRP **£294**



P 101.0153.943

DIMENSIONS	Left to Right: 940mm Front to Back: 510mm
BOWL DIMENSIONS	Left to Right: 360mm Front to Back: 420mm
BOWL DEPTH	200mm
CUT OUT DIMENSIONS	Left to Right: 924mm Front to Back: 494mm
MINIMUM CABINET	500mm

OTHER – Suitable for WDU – Yes
Standard Waste included

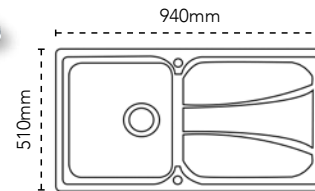

Zeta 100

Shown in Polished Stainless Steel

Pack RRP **£519**
Sink only RRP **£312**



P 101.0043.154

DIMENSIONS	Left to Right: 1030mm Front to Back: 510mm
BOWL DIMENSIONS	Left to Right: 450mm Front to Back: 420mm
BOWL DEPTH	180mm
CUT OUT DIMENSIONS	Left to Right: 1014mm Front to Back: 494mm
MINIMUM CABINET	600mm

OTHER – Suitable for WDU – Yes
Standard Waste included

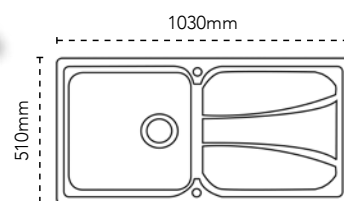

Zeta 150

Shown in Polished Stainless Steel

Pack RRP **£647**
Sink only RRP **£440**

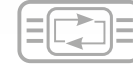

P 101.0153.952

DIMENSIONS	Left to Right: 1030mm Front to Back: 510mm
1ST BOWL DIMENSIONS	Left to Right: 360mm Front to Back: 420mm
2ND BOWL DIMENSIONS	Left to Right: 170mm Front to Back: 320mm
BOWL DEPTH	200mm/130mm
CUT OUT DIMENSIONS	Left to Right: 1014mm Front to Back: 484mm
MINIMUM CABINET	600mm

OTHER – Suitable for WDU – In main bowl only
Standard Waste included

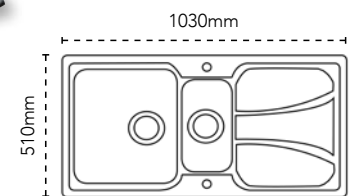

Zeta 90 with Dante Pro tap in Chrome



Atoll 150
with Sift Filter tap
in Chrome

ATOLL

The Atoll Stainless Steel inset sinks are appealing to all kitchen types. With their generously large bowls and crisp drainer grooves, these sinks are both stylish and practical at the same time!

Sinks shown with Henley tap
Henley tap Chrome - 115.0254.448

**Upgrade
to your
ideal tap!**

See our taps range
on pages 41 - 46

Atoll 90

Shown in Polished Stainless Steel

Pack RRP **£462**

Sink only RRP **£255**

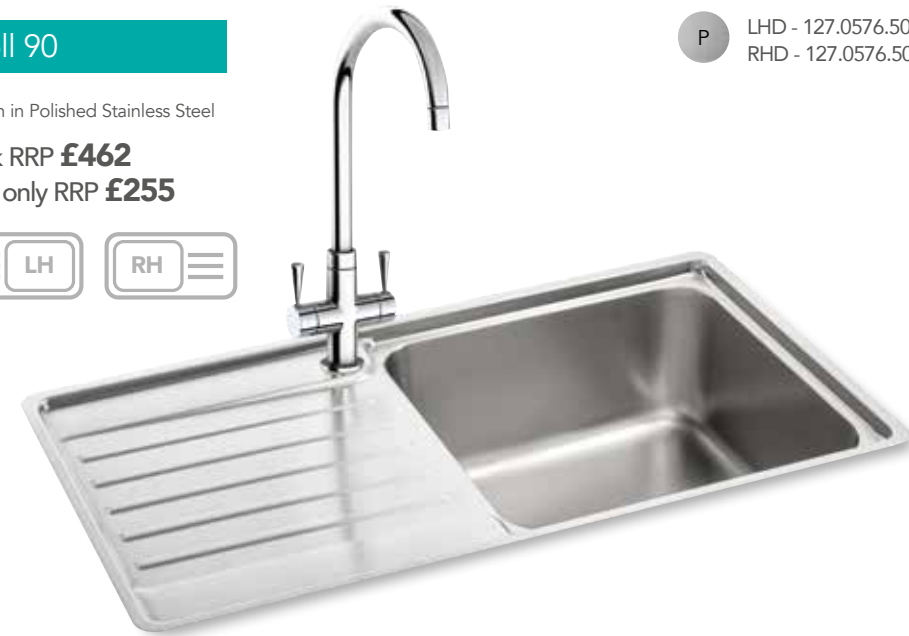

P LHD - 127.0576.501
RHD - 127.0576.502

DIMENSIONS	Left to Right: 860mm Front to Back: 480mm
BOWL DIMENSIONS	Left to Right: 420mm Front to Back: 415mm
BOWL DEPTH	200mm
CUT OUT DIMENSIONS	Left to Right: 837mm Front to Back: 457mm
MINIMUM CABINET	600mm

OTHER – Suitable for WDU – Yes
Standard Waste included

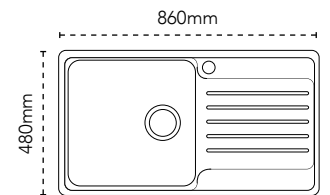

Atoll 150

Shown in Polished Stainless Steel

Pack RRP **£525**

Sink only RRP **£318**

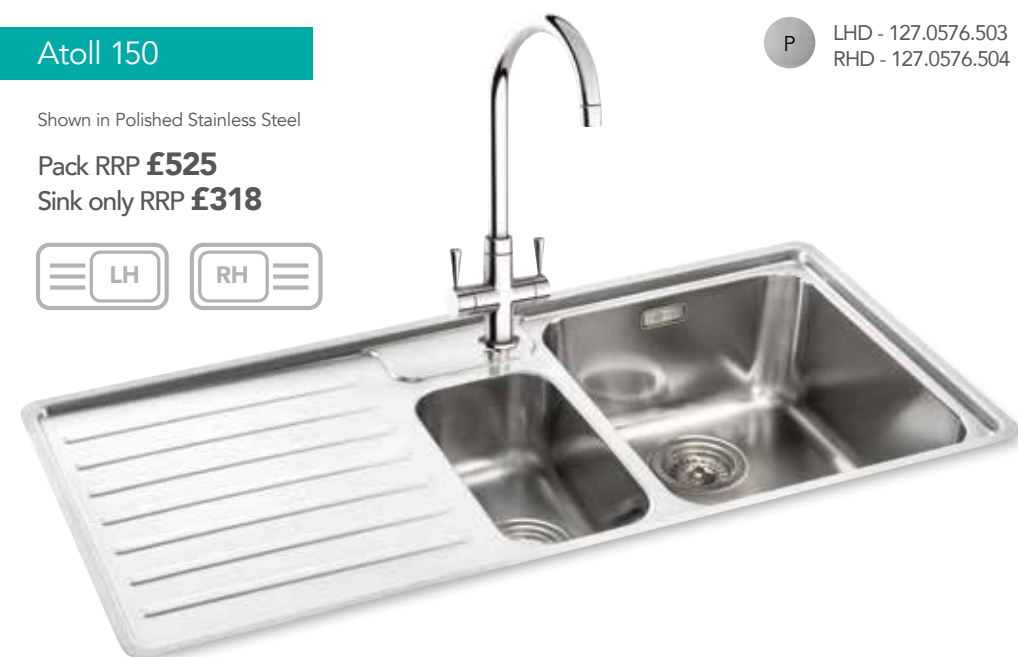

P LHD - 127.0576.503
RHD - 127.0576.504

DIMENSIONS	Left to Right: 1000mm Front to Back: 480mm
1ST BOWL DIMENSIONS	Left to Right: 360mm Front to Back: 415mm
2ND BOWL DIMENSIONS	Left to Right: 170mm Front to Back: 320mm
BOWL DEPTH	200mm/130mm
CUT OUT DIMENSIONS	Left to Right: 976mm Front to Back: 456mm
MINIMUM CABINET	600mm

OTHER – Suitable for WDU – In main bowl only
Standard Waste included

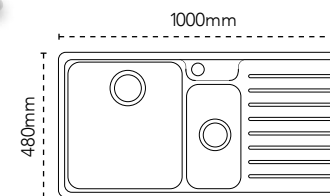

RAPID

Our Rapid range offers classic curves and a modern appearance, available in a brushed chrome finish.

Sinks shown with Henley tap
Henley tap Chrome - 115.0254.448

Rapid 90

Shown in Brushed Chrome

Pack RRP **£409**
Sink only RRP **£202**



B 101.0495.180

DIMENSIONS	Left to Right: 860mm Front to Back: 500mm
BOWL DIMENSIONS	Left to Right: 340mm Front to Back: 400mm
BOWL DEPTH	190mm
CUT OUT DIMENSIONS	Left to Right: 840mm Front to Back: 480mm
MINIMUM CABINET	450mm

OTHER – Suitable for WDU – Yes
Standard Waste included

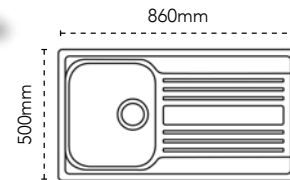

Rapid 150

Shown in Brushed Chrome

Pack RRP **£493**
Sink only RRP **£286**



B 101.0495.211

DIMENSIONS	Left to Right: 1000mm Front to Back: 500mm
BOWL DIMENSIONS	Left to Right: 340mm Front to Back: 400mm
2ND BOWL DIMENSIONS	Left to Right: 160mm Front to Back: 300mm
BOWL DEPTH	190mm/130mm
CUT OUT DIMENSIONS	Left to Right: 980mm Front to Back: 480mm
MINIMUM CABINET	600mm

OTHER – Suitable for WDU – In main bowl only
Standard Waste included

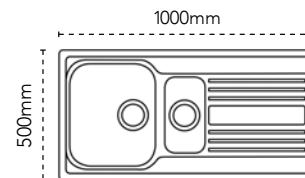

Rapid 150 with Zeno tap in Chrome



LOMOND NEW

Our Lomond sinks offer excellent value for money whilst combining good looks with high performance and durability.

**Upgrade
to your
ideal tap!**

See our taps range
on pages 41 - 46

**Upgrade
to your
ideal tap!**

See our taps range
on pages 41 - 46

Sinks shown with Henley tap
Henley tap Chrome - 115.0254.448

Sinks shown with Henley tap
Henley tap Chrome - 115.0254.448

Lomond 90 NEW

Shown in Unbrushed Stainless Steel

Pack RRP **£352**
Sink only RRP **£145**



U 101.0714.473

DIMENSIONS	Left to Right: 860mm Front to Back: 500mm
BOWL DIMENSIONS	Left to Right: 340mm Front to Back: 420mm
BOWL DEPTH	160mm
CUT OUT DIMENSIONS	Left to Right: 840mm Front to Back: 480mm
MINIMUM CABINET	450mm

OTHER – Suitable for WDU – Yes
Standard Waste included

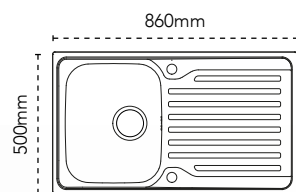

Lomond 100 NEW

Shown in Unbrushed Stainless Steel

Pack RRP **£371**
Sink only RRP **£164**

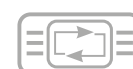

U 101.0714.474

DIMENSIONS	Left to Right: 1000mm Front to Back: 500mm
BOWL DIMENSIONS	Left to Right: 480mm Front to Back: 420mm
BOWL DEPTH	160mm
CUT OUT DIMENSIONS	Left to Right: 980mm Front to Back: 480mm
MINIMUM CABINET	600mm

OTHER – Suitable for WDU – Yes
Standard Waste included

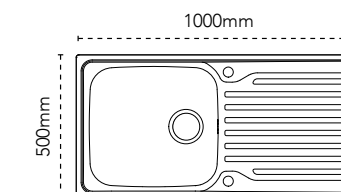

Lomond 150 NEW

Shown in Unbrushed Stainless Steel

Pack RRP **£400**
Sink only RRP **£193**



U 101.0714.475

DIMENSIONS	Left to Right: 1000mm Front to Back: 500mm
1ST BOWL DIMENSIONS	Left to Right: 340mm Front to Back: 420mm
2ND BOWL DIMENSIONS	Left to Right: 170mm Front to Back: 280mm
BOWL DEPTH	160mm/90mm
CUT OUT DIMENSIONS	Left to Right: 980mm Front to Back: 480mm
MINIMUM CABINET	600mm

OTHER – Suitable for WDU – Yes
Standard Waste included

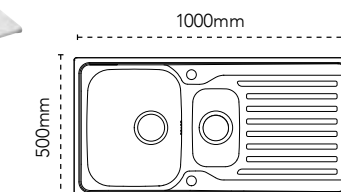

Lomond 150
with Dante tap
in Chrome

DECA INSET / UNDERMOUNT

Deca is a superb example of minimalist practicality and style, featuring a 12mm bowl corner radii across all models. Each Deca model can be installed either as an inset or undermount.

Upgrade to your ideal tap!

See our taps range on pages 41 - 46

Upgrade to your ideal tap!

See our taps range on pages 41 - 46

Sinks shown with Henley tap
Henley tap Chrome - 115.0254.448

Sinks shown with Henley tap
Henley tap Chrome - 115.0254.448

Deca 100

Shown in Polished Stainless Steel
Shown inset

Pack RRP **£753**
Sink only RRP **£546**



P 127.0442.744

ACCESSORY **£40** - 112.0018.988



DIMENSIONS	Left to Right: 400mm Front to Back: 450mm
BOWL DIMENSIONS	Left to Right: 360mm Front to Back: 410mm
BOWL DEPTH	200mm
CUT OUT DIMENSIONS (inset only)	Use template to u/mount Left to Right: 370mm Front to back: 420mm
MINIMUM CABINET	450mm

OTHER – Suitable for WDU – Yes
Revolution Waste included

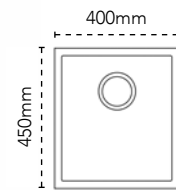

Deca 105

Shown in Polished Stainless Steel
Shown undermount

Pack RRP **£795**
Sink only RRP **£588**



P 127.0442.745

ACCESSORY **£61** - 112.0178.435



DIMENSIONS	Left to Right: 540mm Front to Back: 450mm
BOWL DIMENSIONS	Left to Right: 500mm Front to Back: 410mm
BOWL DEPTH	200mm
CUT OUT DIMENSIONS (inset only)	Use template to u/mount Left to Right: 510mm Front to back: 420mm
MINIMUM CABINET	550mm

OTHER – Suitable for WDU – Yes
Revolution Waste included

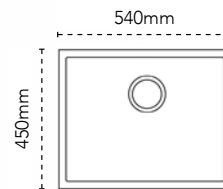

Deca 150

Shown in Polished Stainless Steel
Shown inset

Pack RRP **£1030**
Sink only RRP **£823**



P LHSB - 127.0442.746
RHSB - 127.0442.747

ACCESSORY **£40** - 112.0018.988



DIMENSIONS	Left to Right: 560mm Front to Back: 450mm
1ST BOWL DIMENSIONS	Left to Right: 340mm Front to Back: 410mm
2ND BOWL DIMENSIONS	Left to Right: 160mm Front to Back: 410mm
BOWL DEPTH	200mm/140mm
CUT OUT DIMENSIONS (inset only)	Use template to u/mount Left to Right: 530mm Front to Back: 420mm
MINIMUM CABINET	600mm

OTHER – Suitable for WDU – Yes
Revolution Waste included

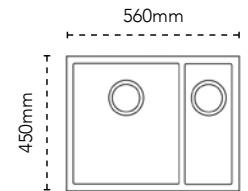

Deca XL

Shown in Polished Stainless Steel
Shown inset

Pack RRP **£822**
Sink only RRP **£615**



P 127.0437.219

DIMENSIONS	Left to Right: 725mm Front to Back: 450mm
BOWL DIMENSIONS	Left to Right: 685mm Front to Back: 410mm
BOWL DEPTH	200mm
CUT OUT DIMENSIONS (Inset only)	Use template to u/mount Left to Right: 695mm Front to Back: 420mm
MINIMUM CABINET	800mm

OTHER – Suitable for WDU – Yes
Revolution Waste included

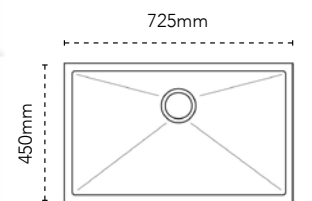



Deca 150 with Dante tap in Chrome

ZETA UNDERMOUNT

Zeta's undermount models are simple, classic with soft, rounded corners creating a sleek, seamless look that is easy to keep clean.

Upgrade to your ideal tap!

See our taps range on pages 41 - 46

Sinks shown with Henley tap
Henley tap Chrome - 115.0254.448

Zeta 105U/50U

P 105U - 122.0167.719
50U - 122.0167.705

ACCESSORY £42 - 112.0070.876



Wire Basket

	105U	50U
DIMENSIONS	Left to Right: 494mm Front to Back: 464mm	205mm 365mm
BOWL DIMENSIONS	Left to Right: 450mm Front to Back: 420mm	170mm 320mm
BOWL DEPTH	200mm	130mm
CUT OUT DIMENSIONS	Use template	Use template
MINIMUM CABINET	500mm	300mm

105U: OTHER - Suitable for WDU - Yes
Standard Waste included

50U: OTHER - Suitable for WDU - No
Standard Waste included

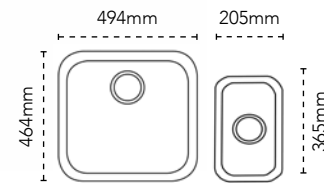

Shown in Polished Stainless Steel

105U Pack RRP **£561**
105U Sink only RRP **£354**
50U Pack RRP **£445**
50U Sink only RRP **£238**



Zeta 150U

P 122.0167.720

ACCESSORY £42 - 112.0070.876



Wire Basket

	Left to Right:	Front to Back:
DIMENSIONS	600mm	465mm
1ST BOWL DIMENSIONS	360mm	420mm
2ND BOWL DIMENSIONS	170mm	320mm
BOWL DEPTH	200mm/130mm	
CUT OUT DIMENSIONS	Use template	
MINIMUM CABINET	600mm	

OTHER - Suitable for WDU - In main bowl only
Standard Waste included

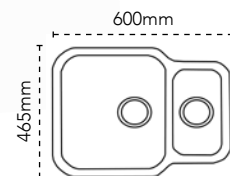

Shown in Polished Stainless Steel

Pack RRP **£623**
Sink only RRP **£416**



IBIS UNDERMOUNT

The appeal of Ibis lies in its absolute simplicity. Clean lines and contemporary styling are echoed throughout the Ibis range.

Upgrade to your ideal tap!

See our taps range on pages 41 - 46

Sinks shown with Henley tap
Henley tap Chrome - 115.0254.448

Ibis 100U

P 122.0281.513

Shown in Polished Stainless Steel

Pack RRP **£475**
Sink only RRP **£268**



DIMENSIONS	Left to Right: 400mm Front to Back: 460mm
BOWL DIMENSIONS	Left to Right: 360mm Front to Back: 420mm
BOWL DEPTH	200mm
CUT OUT DIMENSIONS	Use template
MINIMUM CABINET	400mm

OTHER - Suitable for WDU - Yes
Revolution Waste included

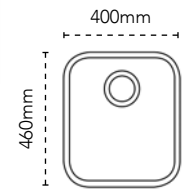

Ibis 150U

P LHSB - 122.0284.072
RHSB - 122.0284.074

Shown in Polished Stainless Steel

Pack RRP **£653**
Sink only RRP **£446**



DIMENSIONS	Left to Right: 600mm Front to Back: 465mm
1ST BOWL DIMENSIONS	Left to Right: 360mm Front to Back: 420mm
2ND BOWL DIMENSIONS	Left to Right: 170mm Front to Back: 320mm
BOWL DEPTH	180mm / 130mm
CUT OUT DIMENSIONS	Use template
MINIMUM CABINET	600mm

OTHER - Suitable for WDU - Yes
Revolution Waste included

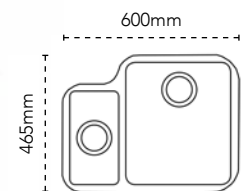



Upgrade
to your
ideal tap!

See our taps range
on pages 41 - 46

Ibis 150U
with Reno tap
in Onyx

CARISMA INSET / UNDERMOUNT

Carisma brings together sound design that makes this range a practical and durable choice.

Sinks shown with Henley tap
Henley tap Chrome - 115.0254.448

Carisma 400

Shown in Polished Stainless Steel

Pack RRP **£411**
Sink only RRP **£204**



P 101.0694.342

DIMENSIONS	Left to Right: 435mm Front to Back: 435mm
BOWL DIMENSIONS	Diameter: 378.8mm
BOWL DEPTH	170mm
CUT OUT DIMENSIONS	Diameter: 415mm
MINIMUM CABINET	450mm

OTHER – Suitable for WDU – Yes
Standard Waste included

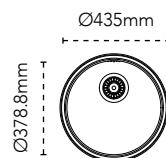

CERAMIC



Shonelle 150
with Windsor tap

Ceramic is a respected classic.

With its lustrous glossy glaze, a Ceramic sink combines beauty with distinction.



Each Carron Phoenix sink is supported by a **Lifetime Guarantee** against manufacturing defects.



WHITE

Ceramic is a hard-working, non-porous surface that is easy to clean and extremely resistant to heat and chemicals.

Our Ceramic sinks are traditionally manufactured from fine-fireclay that is fired at high temperatures and then individually finished by hand. This ensures their fine quality with a true depth of colour and an impeccable smooth surface.

SIENNA

The Sienna is a stylish and classic Ceramic sink, suited to both traditional and more contemporary kitchens.

Sinks shown with Henley tap
Henley tap Chrome - 115.0254.448

Upgrade
to your
ideal tap!

See our taps range
on pages 41 - 46

Sienna 100

Shown in White

Pack RRP **£591**
Sink only RRP **£384**



WH 124.0188.034

DIMENSIONS	Left to Right: 1010mm Front to Back: 525mm
BOWL DIMENSIONS	Left to Right: 455mm Front to Back: 410mm
BOWL DEPTH	210mm
CUT OUT DIMENSIONS	Template supplied: 970mm x 494mm CR-0mm
MINIMUM CABINET	600mm (40mm Worktop) 1000mm (30mm Worktop)

OTHER – Suitable for WDU – Yes
Standard Waste included

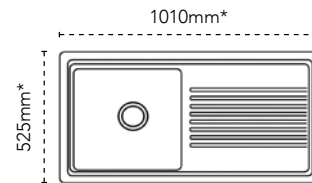

Please note:
An extended flange is
required if fitting a WDU
to this Ceramic sink.

*Ceramic sink dimensions may vary
± 2% due to firing process.

Sienna 150

Shown in White

Pack RRP **£602**
Sink only RRP **£395**



WH 124.0188.036

DIMENSIONS	Left to Right: 1010mm Front to Back: 525mm
1ST BOWL DIMENSIONS	Left to Right: 330mm Front to Back: 410mm
2ND BOWL DIMENSIONS	Left to Right: 165mm Front to Back: 270mm
BOWL DEPTH	210mm/120mm
CUT OUT DIMENSIONS	Template supplied: 970mm x 494mm CR-0mm
MINIMUM CABINET	600mm (40mm Worktop) 1000mm (30mm Worktop)

OTHER – Suitable for WDU – Yes
Standard Waste included

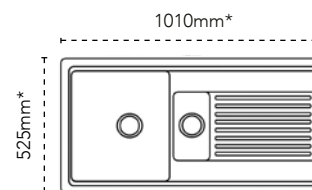

Please note:
An extended flange is
required if fitting a WDU
to this Ceramic sink.

*Ceramic sink dimensions may vary
± 2% due to firing process.

SHONELLE

Shonelle offers a contemporary interpretation of the classic Ceramic sink. Each of the models balances stylish good looks with practical ergonomics and offers design versatility for contemporary kitchens.

Sinks shown with Henley tap
Henley tap Chrome - 115.0254.448

Upgrade
to your
ideal tap!

See our taps range
on pages 41 - 46

Shonelle 105

Shown in White

Pack RRP **£625**
Sink only RRP **£418**



WH 124.0477.792

DIMENSIONS	Left to Right: 920mm Front to Back: 510mm
BOWL DIMENSIONS	Left to Right: 410mm Front to Back: 410mm
BOWL DEPTH	220mm
CUT OUT DIMENSIONS	Template supplied: 895mm x 485mm CR-0mm
MINIMUM CABINET	600mm

OTHER – Suitable for WDU – Yes
Standard Waste included

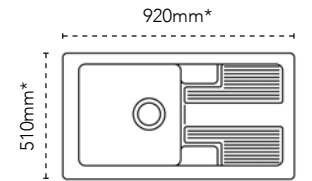

Please note:
An extended flange is
required if fitting a WDU
to this Ceramic sink.

*Ceramic sink dimensions may vary
± 2% due to firing process.

Shonelle 150

Shown in White

Pack RRP **£641**
Sink only RRP **£434**



WH 124.0477.793

DIMENSIONS	Left to Right: 1010mm Front to Back: 510mm
1ST BOWL DIMENSIONS	Left to Right: 360mm Front to Back: 420mm
2ND BOWL DIMENSIONS	Left to Right: 130mm Front to Back: 260mm
BOWL DEPTH	220mm/120mm
CUT OUT DIMENSIONS	Template supplied: 975mm x 485mm CR-0mm
MINIMUM CABINET	600mm

OTHER – Suitable for WDU – Yes
Standard Waste included

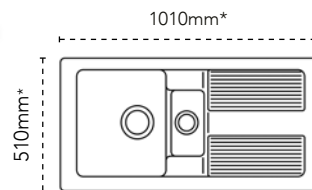

Please note:
An extended flange is
required if fitting a WDU
to this Ceramic sink.

*Ceramic sink dimensions may vary
± 2% due to firing process.



Upgrade to your ideal tap!

See our taps range on pages 41 - 46

Upgrade to your ideal tap!

See our taps range on pages 41 - 46

BELFAST

Belfast sinks bring together classic styling and good old-fashioned charm, yet they fit well with contemporary and traditional kitchens alike. Our single bowl Belfast sink is available with either a traditional weir or a more modern integrated overflow.

Sinks shown with Henley tap
Henley tap Chrome - 115.0254.448

Belfast 100

Shown in White

Pack RRP **£625**
Sink only RRP **£418**



WH 124.0477.726

DIMENSIONS	Left to Right: 595mm Front to Back: 475mm
OVERALL HEIGHT	220mm
BOWL DIMENSIONS	Left to Right: 550mm Front to Back: 420mm
BOWL DEPTH	220mm
CUT OUT DIMENSIONS	Use sink as template
MINIMUM CABINET	600mm

OTHER – Suitable for WDU – Yes
Standard Waste included

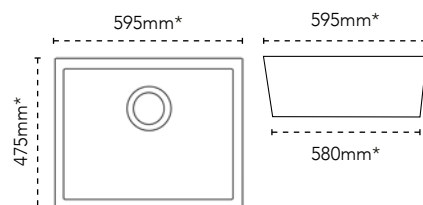

Please note:
An extended flange is required if fitting a WDU to this Ceramic sink.

*Ceramic sink dimensions may vary ± 2% due to firing process.

Belfast 110

Shown in White

Pack RRP **£625**
Sink only RRP **£418**



WH 124.0477.727

DIMENSIONS	Left to Right: 595mm Front to Back: 455mm
OVERALL HEIGHT	250mm
BOWL DIMENSIONS	Left to Right: 525mm Front to Back: 385mm
BOWL DEPTH	215mm
CUT OUT DIMENSIONS	Use sink as template
MINIMUM CABINET	600mm

OTHER – Suitable for WDU – No
Mini Waste included

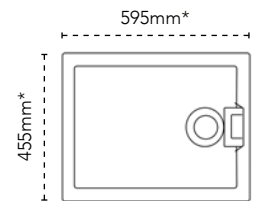

*Ceramic sink dimensions may vary ± 2% due to firing process.

Belfast 200

Shown in White

Pack RRP **£752**
Sink only RRP **£545**



WH 124.0477.749

DIMENSIONS	Left to Right: 800mm Front to Back: 490mm
OVERALL HEIGHT	220mm
1ST BOWL DIMENSIONS	Left to Right: 365mm Front to Back: 450mm
2ND BOWL DIMENSIONS	Left to Right: 365mm Front to Back: 450mm
BOWL DEPTH	200mm
CUT OUT DIMENSIONS	Use sink as template
MINIMUM CABINET	800mm

OTHER – Suitable for WDU – Yes
Standard Waste included

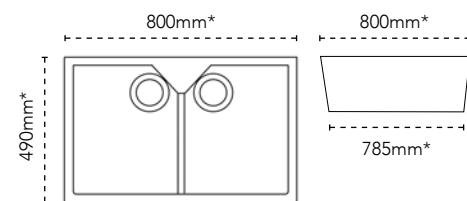

Please note:
An extended flange is required if fitting a WDU to this Ceramic sink.

*Ceramic sink dimensions may vary ± 2% due to firing process.

CARLOW

The Carlow range offers an exceptional crossover between classic Ceramic and the modern method of undermounting. The soft lines in each model are complemented by the crisp white Ceramic.

Upgrade
to your
ideal tap!

See our taps range
on pages 41 - 46

Sinks shown with Henley tap
Henley tap Chrome - 115.0254.448

Carlow 105

Shown in White

Pack RRP **£597**
Sink only RRP **£390**



WH 126.0659.184

ACCESSORY **£42** - 112.0070.876



Wire
Basket

DIMENSIONS	Left to Right: 545mm Front to Back: 440mm
BOWL DIMENSIONS	Left to Right: 492mm Front to Back: 388mm
BOWL DEPTH	176mm
CUT OUT DIMENSIONS	Use sink as template
MINIMUM CABINET	600mm

OTHER – Suitable for WDU – Yes
Revolution Waste included

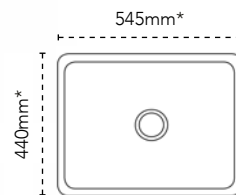

Please note:
An extended flange is
required if fitting a WDU
to this Ceramic sink.

*Ceramic sink
dimensions may
vary ± 2% due to
firing process.

Carlow 150

Shown in White

Pack RRP **£724**
Sink only RRP **£517**



WH 126.0659.185

ACCESSORY **£40** - 112.0018.988



Wire
Basket

DIMENSIONS	Left to Right: 490mm Front to Back: 440mm
1ST BOWL DIMENSIONS	Left to Right: 332mm Front to Back: 386mm
2ND BOWL DIMENSIONS	Left to Right: 144mm Front to Back: 274mm
BOWL DEPTH	176mm / 120mm
CUT OUT DIMENSIONS	Use sink as template
MINIMUM CABINET	600mm

OTHER – Suitable for WDU – In main bowl only
Revolution Waste included

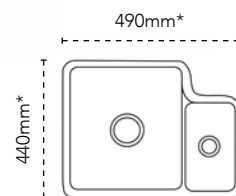

Please note:
An extended flange is
required if fitting a WDU
to this Ceramic sink.

*Ceramic sink
dimensions may
vary ± 2% due to
firing process.

WATERFORD INSET / UNDERMOUNT

Echoing the plain and simple design of a Belfast sink, the Waterford range of sinks can be installed as inset sinks or they can be undermounted.

Upgrade
to your
ideal tap!

See our taps range
on pages 41 - 46

Sinks shown with Henley tap
Henley tap Chrome - 115.0254.448

Waterford 50/100

Shown in White
Shown undermounted

50 Pack RRP **£523**
50 Sink only RRP **£316**

100 Pack RRP **£555**
100 Sink only RRP **£348**

WH 50 - 124.0477.750
100 - 124.0477.791



Waterford 100

Waterford 50

DIMENSIONS	Left to Right: 450mm Front to Back: 475mm	Left to Right: 250mm Front to Back: 475mm
BOWL DIMENSIONS	Left to Right: 380mm Front to Back: 405mm	Left to Right: 180mm Front to Back: 405mm
BOWL DEPTH	180mm	130mm
CUT OUT DIMENSIONS	Use sink as template	Use sink as template
MINIMUM CABINET	500mm	300mm

OTHER –
Suitable for WDU – Yes
Standard Waste included

OTHER –
Suitable for WDU – No
Standard Waste included

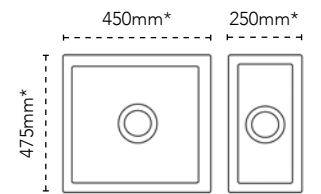

Please note:
An extended flange is
required if fitting a WDU
to this Ceramic sink.

*Ceramic sink
dimensions may vary
± 2% due to firing process.



TAPS

Our tap range has been specially designed to give you all the options you need to complement your Carron Phoenix sink.

Whether you are looking for a contemporary, traditional or designer style, single or double lever operation, or a filter tap, we have a selection of high quality and attractive taps for you to choose from.



Depending on the style and age of your house, you may require a specific style of tap, a model that is appropriate to the water pressure available in your kitchen. Specifically, many older properties will require a tap which has been designed to work best with lower water pressure or gravity fed systems. So, if you know your property has low water pressure, choose a tap suitable for low pressure systems. If you have a high pressure system you can choose any tap. See the icon below next to tap of your choice for the recommended water pressure needed.



Each Carron Phoenix mixer tap is supported by a **Five year comprehensive Guarantee** against manufacturing defects.

Household water pressures
(minimum tap flow rating)

LOW PRESSURE	MED PRESSURE	HIGH PRESSURE
0.2-0.5 bar	0.5-1.2 bar	1.2-1.5+ bar

CH	DS	ON	MB	BR
CHROME	DECOR STEEL	ONYX	MATT BLACK	BRASS

FILTER TAPS

DANTE TRI-PURE

Dante Tri-Pure Filter offers excellent filtration performance thanks to its double filtration system of charcoal and ceramics specially impregnated with silver particles.

The filter removes unwanted chlorine, cryptosporidium and other harmful bacteria and particles, yet leaving you with the minerals that are good for you.

CH 120.0193.061
RRP **£579**

	Perlator		MED PRESSURE
--	----------	--	--------------

TAP DIMENSIONS

Tap Height: 390mm
Base Width: 60mm
Spout Height: 260mm
Spout Reach: 220mm
Finish: Chrome

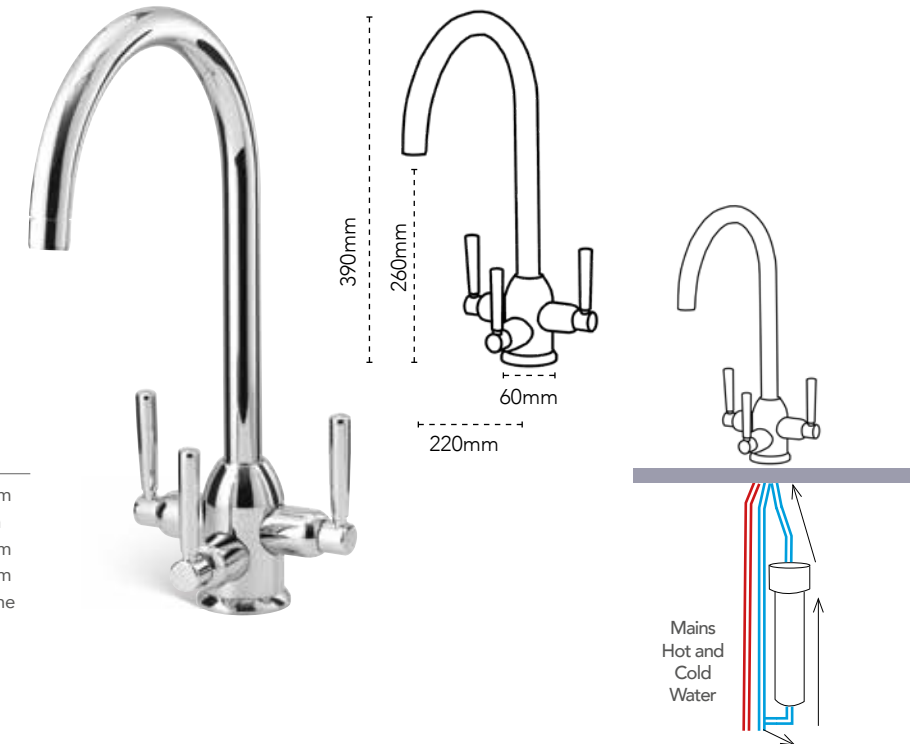

SIFT FILTER

Add a touch of class to your kitchen with the Sift filtered water tap. Available in chrome, this graceful swan neck tap boasts a modern styling.

The limescale reduction filter system improves the taste of the water, whilst also reducing limescale, odour and sediment.

CH 120.0608.887
RRP **£362**

	Perlator		MED PRESSURE
--	----------	--	--------------

TAP DIMENSIONS

Tap Height: 397mm
Base Width: 48mm
Spout Height: 272mm
Spout Reach: 216mm
Finish: Chrome, Decor Steel, Matt Black



MIXER TAPS



A comprehensive selection of precision-made taps to complement your Carron Phoenix sink, available in a number of styles and finishes to suit your own personal taste.



Dante Pro

Pull-Out Nozzle

CH 115.0191.084
RRP **£380**



Perlator

TAP DIMENSIONS

Tap Height: 538mm
Base Width: 60mm
Spout Height: 210mm
Spout Reach: 188mm
Finish: Chrome

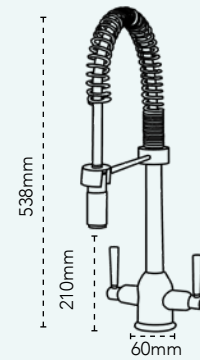

Dante Pull-Out

Pull-Out Spray

CH B 115.0433.945
RRP **£380**



Perlator

TAP DIMENSIONS

Tap Height: 477mm
Base Width: 60mm
Spout Height: 219mm
Spout Reach: 195mm
Finish: Chrome

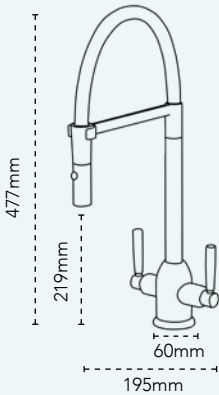

Barra

CH 115.0074.732
RRP **£335**



TAP DIMENSIONS

Tap Height: 365mm
Base Width: 240mm
Spout Height: 265mm
Spout Reach: 180mm
Finish: Chrome

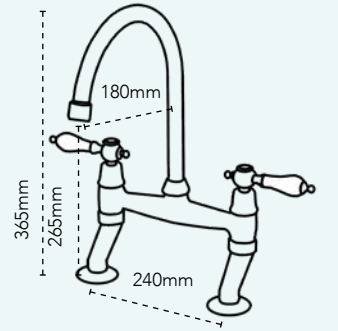

Rosolina L Spout

CH 115.0605.455
RRP **£330**

MB 115.0605.457
RRP **£361**

BR 115.0689.773
RRP **£430**



Perlator

TAP DIMENSIONS

Tap Height: 282mm
Base Width: 48mm
Spout Height: 252mm
Spout Reach: 212mm
Finish: Chrome
Decor Steel
Matt Black

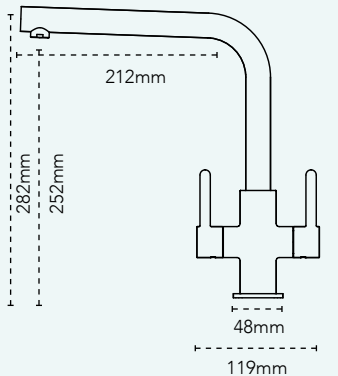

Dante

CH 115.0068.382
RRP **£306**

DS 115.0068.384
RRP **£320**



Perlator

TAP DIMENSIONS

Tap Height: 390mm
Base Width: 60mm
Spout Height: 260mm
Spout Reach: 220mm
Finish: Chrome
Decor Steel

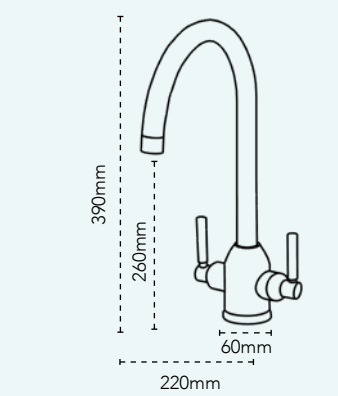

Reno

CH 115.0029.805
RRP **£294**

ON 115.0189.492
RRP **£303**



Perlator

TAP DIMENSIONS

Tap Height: 257mm
Base Width: 47mm
Spout Height: 160mm
Spout Reach: 181mm
Finish: Chrome
Stone Grey
Onyx

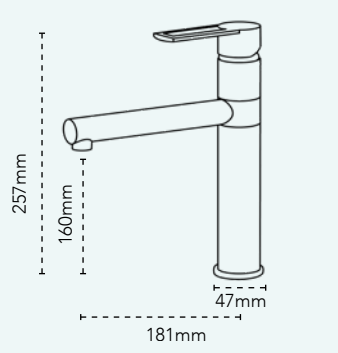

Windsor

CH 115.0281.850
RRP **£270**

BR 115.0689.775
RRP **£351**

LOW
PRESSURE



TAP DIMENSIONS

Tap Height: 343mm
Base Width: 44mm
Spout Height: 213mm
Spout Reach: 194mm
Finish: Chrome
Brass

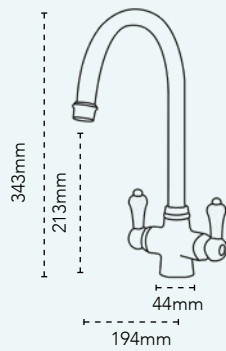

Rosolina J Spout

CH 115.0605.452
RRP **£330**

MB 115.0605.454
RRP **£361**

BR 115.0689.772
RRP **£430**

MED
PRESSURE



TAP DIMENSIONS

Tap Height: 356mm
Base Width: 48mm
Spout Height: 242mm
Spout Reach: 215mm
Finish: Chrome

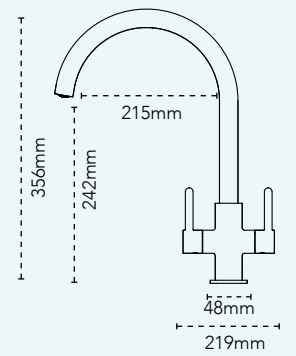

Alba

CH 115.0068.379
RRP **£239**

DS 115.0188.558
RRP **£262**

LOW
PRESSURE



TAP DIMENSIONS

Tap Height: 350mm
Base Width: 50mm
Spout Height: 220mm
Spout Reach: 190mm
Finish: Chrome
Decor Steel

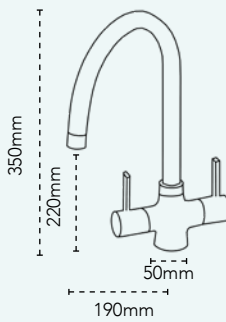

Savoy

CH 115.0254.455
RRP **£174**

MB 115.0605.320
RRP **£205**

BR 115.0689.774
RRP **£337**

MED
PRESSURE



TAP DIMENSIONS

Tap Height: 384mm
Base Width: 45mm
Spout Height: 240mm
Spout Reach: 189mm
Finish: Chrome
Decor Steel
Matt Black
Brass

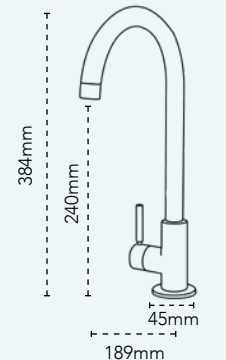

Opus

CH 115.0019.224
RRP **£209**

DS 115.0019.236
RRP **£260**

LOW
PRESSURE



TAP DIMENSIONS

Tap Height: 300mm
Base Width: 45mm
Spout Height: 225mm
Spout Reach: 160mm
Finish: Chrome
Decor Steel

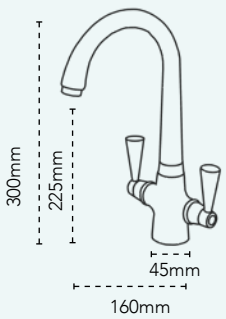

Aztec

CH 115.0019.342
RRP **£133**

LOW
PRESSURE



TAP DIMENSIONS

Tap Height: 245mm
Base Width: 45mm
Spout Height: 210mm
Spout Reach: 230mm
Finish: Chrome

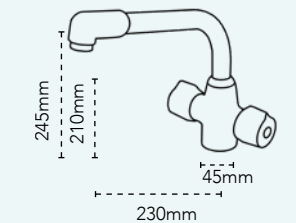

Henley

CH 115.0254.448
RRP **£207**

MED
PRESSURE



TAP DIMENSIONS

Tap Height: 363mm
Base Width: 45mm
Spout Height: 223mm
Spout Reach: 194mm
Finish: Chrome

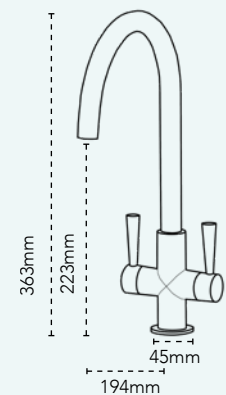

Zeno

CH 115.0363.799
RRP **£88**

MED
PRESSURE



TAP DIMENSIONS

Tap Height: 115mm
Base Width: 44mm
Spout Height: 210mm
Spout Reach: 214mm
Finish: Chrome

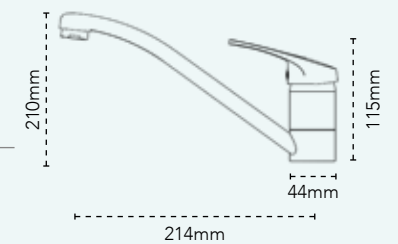

WASTE MANAGEMENT

With the environment in mind, we have a range of waste management solutions that can help you dispose of your waste in a highly efficient and eco-friendly way.

A quick, easy and efficient way to prevent organic waste going into landfill!



Carronade Elite Waste Disposal Units

Waste disposal units are very easily installed with the current plumbing under your sink and are easy to operate.

Our premium specification products are sound insulated for a quiet operation, are septic safe and incredibly efficient. Carronade Elite waste disposal units are suitable for every day use. Food is fed into the disposer as it operates.

On/off control is operated by a separate air switch which is supplied.



Waste Sorter Bins

Carron Phoenix waste sorter bins can be fitted easily into a kitchen cabinet and will help you to effectively segregate your waste prior to collection. With a range of configurations to choose from, each model features removable bin inserts and covers to contain odours.



CARRONADE ELITE WASTE DISPOSAL UNITS

Carronade Elite CE-50

134.0473.240
RRP **£290**

An extended flange is available if required at extra cost when fitting to ceramic sinks

RRP **£47**



DIMENSIONS

Height: 354mm
Width: 132mm

TECHNICAL SPECIFICATIONS

Horsepower: 1/2
rpm: 2600
Capacity: 600ml
Operation: Continuous
Power: Airswitch
Sound insulation: Full
Warranty: 3 Years

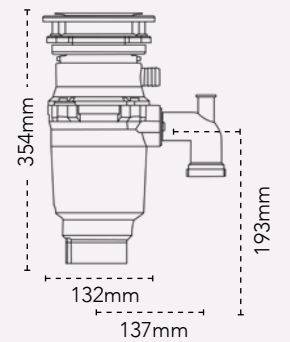

Carronade Elite CE-75

134.0473.271
RRP **£412**

An extended flange is available if required at extra cost when fitting to ceramic sinks

RRP **£47**



DIMENSIONS

Height: 386mm
Width: 220mm

TECHNICAL SPECIFICATIONS

Horsepower: 3/4
rpm: 2700
Capacity: 800ml
Operation: Continuous
Power: Airswitch
Sound insulation: Full
Warranty: 10 Years

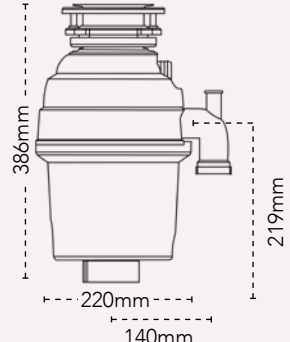

WASTE SORTER BINS

Linea 130

134.0204.152
RRP **£115**



DIMENSIONS

Height: 423mm
Width: 253mm
Depth: 467mm

TECHNICAL SPECIFICATIONS

Number of bins: 1
Capacity: 1 x 30 litres
Min. cabinet: 300mm
Operation: Manual
Warranty: 2 years

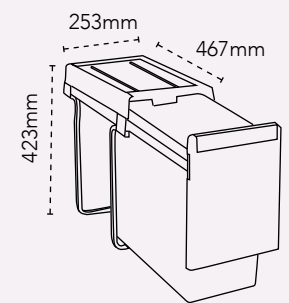

Linea 230

134.0204.599
RRP **£115**



DIMENSIONS

Height: 423mm
Width: 253mm
Depth: 467mm

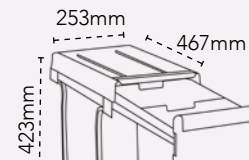

TECHNICAL SPECIFICATIONS

Number of bins: 2
Capacity: 2 x 15 litres
Min. cabinet: 300mm
Operation: Manual
Warranty: 2 years

Linea 330

134.0204.153
RRP **£115**



DIMENSIONS

Height: 423mm
Width: 253mm
Depth: 467mm

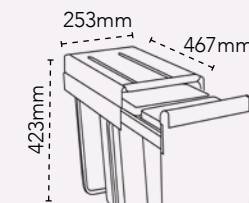

TECHNICAL SPECIFICATIONS

Number of bins: 3
Capacity: 3 x 10 litres
Min. cabinet: 300mm
Operation: Manual
Warranty: 2 years

Linea 332

134.0074.068
RRP **£145**



DIMENSIONS

Height: 340mm
Width: 438mm
Depth: 330mm

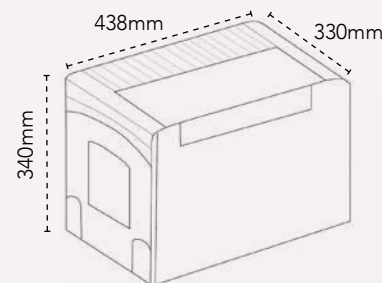

TECHNICAL SPECIFICATIONS

Number of bins: 3
Capacity: 1 x 16 litres
2 x 8 litres
Min. cabinet: 500mm
Operation: Manual
Warranty: 2 years

Linea 360

134.0079.062
RRP **£230**



DIMENSIONS

Height: 423mm
Width: 506mm
Depth: 467mm

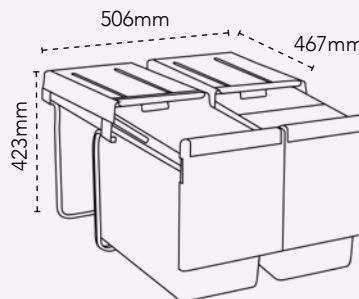

TECHNICAL SPECIFICATIONS

Number of bins: 3
Capacity: 1 x 30 litres
2 x 15 litres
Min. cabinet: 300mm
Operation: Manual
Warranty: 2 years



CARRON
PHOENIX



CARRON
PHOENIX

Carron Phoenix

Franke UK Ltd
West Park, MIOC,
Styal Road,
Manchester
M22 5WB

Tel: 0161 436 6280
Email: ks-info.gb@carron.com
www.carron.com

994.0729.842
CP/09/24/07



Front cover shows 'The Kelpies' in Falkirk, created by artist Andy Scott. They are a man-made wonder, a feat of engineering and the world's largest equine sculptures. Standing at 30 metres high and weighing 300 tonnes each, they are built of structural steel with a stainless steel cladding. Named after mythical Scottish water-horses, 'The Kelpies' are a home to Scotland's horse-powered industrial heritage.